

Pro:Centric SMART

Set Top Box with webOS

▶ STB-3000



Introduction

The STB-3000 is the latest addition to the Pro:Centric family and brings advanced Smart TV functionality to a wide variety of LGE and 3rd party televisions. Designed with multiple interfaces including MPI, MTI and LG TLM (RS-232) the STB-3000 has the ability to interface to most commercial grade televisions currently in use. The STB-3000 can be seamlessly integrated with televisions supporting a commercial control port to include new functionality and provide system integrators a cost effective means to deliver a common user experience across multiple brands of televisions. Consumer grade televisions lacking integrated control functionality are not supported.

The STB-3000 supports the same HTML5 development environment and API (Application Program Interface) as LG's Pro:Centric IPTVs, so that the same third-party applications developed by LG's System Integrator partners can also operate on the set-top-box.

The STB-3000 has new capabilities that optimize the guest experience which include:

- An enhanced Pro:Centric webOS platform which supports multi-threading enabling it to run multiple applications simultaneously
- Bluetooth functionality that allows users to connect their personal devices to stream music
- Access to an expanded list of SMART applications, including "Over-The-Top" video services and games
- Soft Access Point to enable a guest to connect their personal devices for internet access.
- Improved mobile device pairing process for guests using Smart Mirroring.

Features

- **Pro:Centric® Smart IPTV Platform:**
 - Web Browser, Expanded list of Embedded Smart Apps
 - **Guest Connectivity:** Smart Mirroring, Wi-Fi Direct, Wi-Di, Smart Share
- **Embedded Pro:Idiom® decryption for non-Pro:Idiom TV's**
- **IP Streaming and RF Tuning**
- **HD Channel Support** (up to 1080p)
- **Pro:Centric Application Support for non-Pro:Centric TVs**
 - Interactive Electronic Program Guide
 - Gold Application with branded UI and electronic billboards
 - Smart Apps launch (V3.5)
- **Interfaces:** Optical Digital Audio Out, HDMI In/Out, Composite AV, USB, LAN, Display Control1 - TLM, Display Control 2 - MPI/MTI
- **Rear of TV installation** (VESA pattern mounting points)
- **Accessory Kit includes:** PSU and Cables - HDMI, Control, (MPI, MTI, TLM), Composite AV adaptor

SECOND SCREEN CONNECTIVITY / SHARING

The STB-3000 supports "second screen" sharing and options includes Wi-Di™, Wi-Fi Direct™ and Smart Mirroring technologies, which are used to pair guests' mobile devices with the STB enabling them to share and view their content on the large HD screen.

SMART MIRRORING/WI-DI



SMART SHARE



SMART CUSTOMIZATION

LG Pro:Centric® Smart offers SI's the ability to customize and optimize a property's TVs with interactive IP-based applications including HTML5, Java and Flash programs to provide premium hotel services.

CUSTOM USER INTERFACE



PRE-LOADED APPLICATIONS



Pro:Idiom

GLOBAL LEADING DIGITAL RIGHTS MANAGEMENT SYSTEM

Pro:Idiom unlocks access to premium content to help assure rapid and broad deployment of HDTV and other high value digital content.

Pro:Idiom has been designed specifically for users of premium HDTV content from cable, satellite, or video on demand (VOD) services, and is thus designed to lower costs and reduce maintenance needs. This leading DRM system is embraced for its security solution, which prevents illegal copying of copyrighted content.

REDUCED TOTAL COST OF OWNERSHIP



The USB Cloning feature allows you to simply copy the STB's settings onto all STB's using a USB stick, a process that is fully automated to save time without having to set each STB one by one.

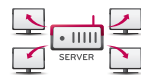

Remote Manager

Using LG's optional Pro:Centric server, you can remotely manage cloning and channel mapping for STB's in guest rooms without having to visit each room.



PCS200R HEAD-END SERVER

Remote management functions are supported via the Pro:Centric server which has an agile frequency QAM or IP output. The Pro:Centric Application software is also supported via the same server to deliver the benefits of LG's Applications features (Weather, EPG, Billboards...)

Auto configuration function makes installation quick and easy with simple steps to guide the installer to set up the STB, saving time and costs.

EZ install provides an auto search and synch' function with the Pro:Centric server data channel to simplify the installation process.

Pro:Centric Applications Platform

The STB-3000 is the latest addition to the of Pro:Centric family that provides a unique and dedicated hotel application platform for hosting LG's SI (System Integrator) Partners interactive applications, enabling delivery for a wide range of custom applications tailored to both hotel management and guest needs.

The STB-3000 is a full IPTV platform with built-in IP video decoding supporting both IP and RF connectivity. Leveraging the Pro:Centric IPTV platform enables SI Partners to integrate their client software directly into the STB to enable control of content on LG and other manufacturers commercial televisions.

The STB-3000 supports embedded Wi-Fi for streaming of content to the Television or back channel communications.

The STB-3000 also includes remote diagnostic tools for partners to manage their systems and monitor the STB's on the network by the head-end or cloud based server for maintenance and admin purposes.

The STB-3000 can also host the LG Pro:Centric Free-to-Guest Application and deliver this to non-Pro:Centric televisions, enabling such features as the interactive electronic programme guide and digital billboards to view information on the property's amenities.

PRO:CENTRIC APPLICATIONS PLATFORM

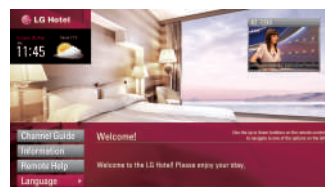

Main Welcome Portal



Channel Guide
Simple Channel List: Select the broadcast logo to watch your selected TV program



Remote Help
Learn how to use the Remote controller with easily accessible menu on TV

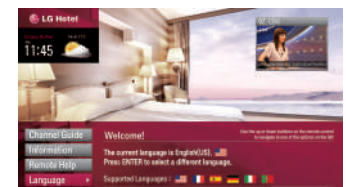

Language
Access the system in multiple languages for international guest service from various nations.

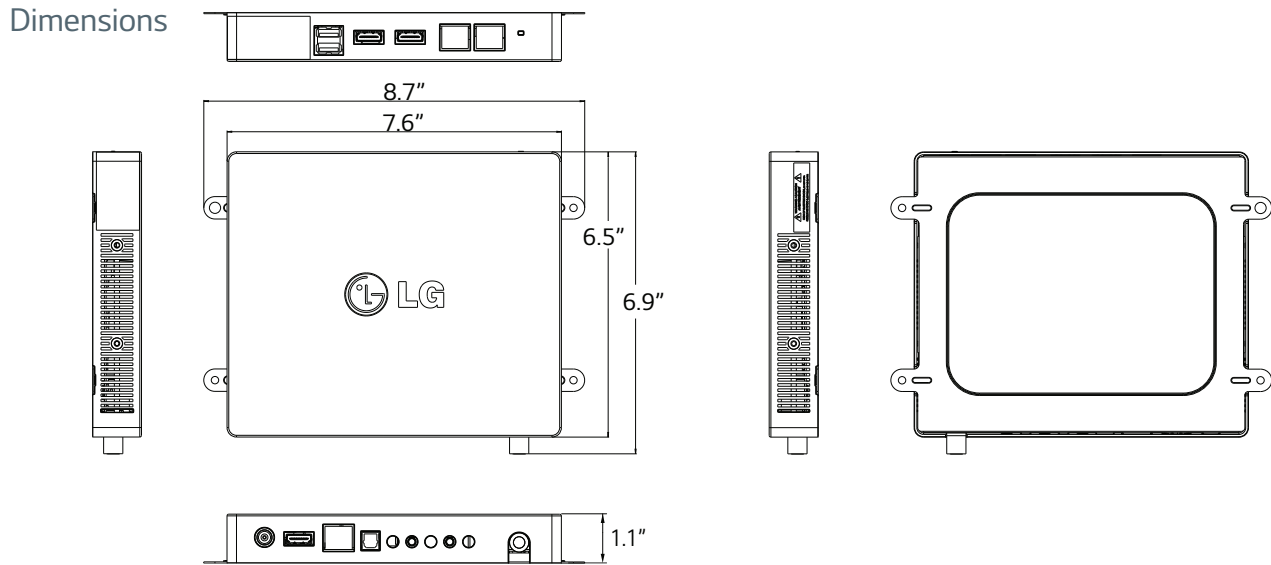
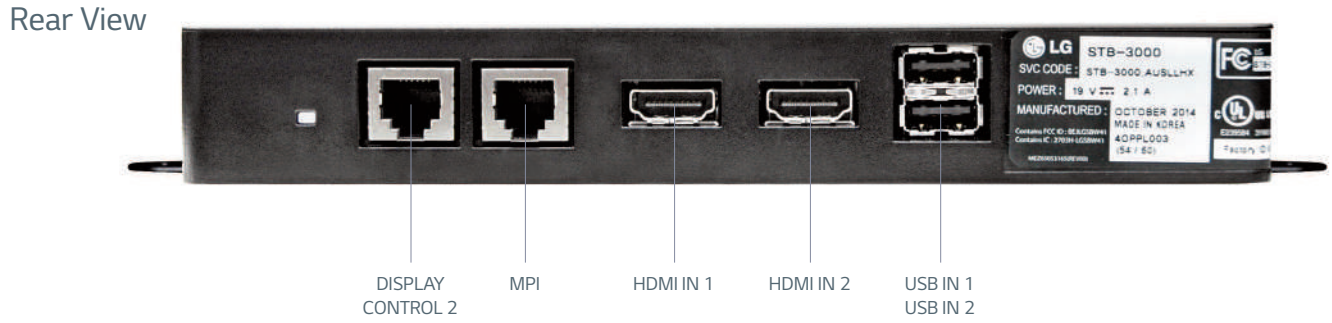
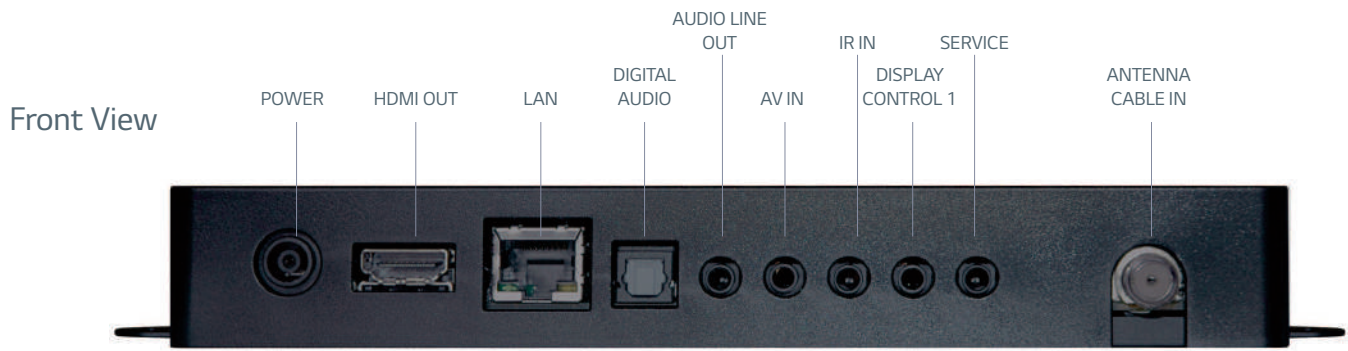

POWER SUPPLY



HDMI CABLE



COMPOSITE A/V CABLE



DISPLAY CONTROL CABLE (RS232)



DISPLAY CONTROL CABLE (MPI/MTI)















Pro:Centric SMART

Set Top Box with webOS

▶ STB-3000

GENERAL SPECIFICATION	Model	STB-3000
GENERAL SPECIFICATION	Dimensions	8.7" x 1.1" x 6.9"
	Weight (w/o package)	1.1 lbs
	Weight (with package)	3.1 lbs
POWER	Voltage, Hz	100 - 240V, 50/60Hz
	Typical (Watts)	15W
	Stand-by	0.3W↓
REQUIRED LISTING (CERTIFICATION)	Safety	UL
	EMC	FCC
	ETC.	RoHS, cUL, NOM, Energy Star 4.1
BROADCASTING SYSTEM	Analog	Yes, NTSC
	Digital	Yes, ATSC, Clear QAM / VSB
VIDEO	Triple XD Engine	Yes
	Output Resolution	720p/1080p/1366x768
AUDIO	Optical Sound Sync	YES (SPDIF)
SPECIAL FEATURES	Pro:Centric Smart	Yes
	Hybrid Streaming (IP & RF) ※ MultiCast/HTTP Data Carousel	Yes
	Pro:Centric Application	YES
	RF (1/2Tuner)	1 Tuner
	HCAP (GEM/FLASH/HTML) ※ Service Carousel (TLX)	Yes
	Auto Configuration	Yes (EZ-Manager)
	Remote Diagnosis	Yes (IP)
	Multicast/Unicast ready	Yes
	IP Streaming	Yes (RTSC, HLS, SNMP, UDP/MultiCast, USB Port/Video Streaming support (Smartshare) ※(IGMPv3 SSM Support)
	Application (P:C Smart)	Yes (Commercial CP/Apps)
	DLNA(Movie/Photo/Music)	Yes (Smart share)
	Miracast (Mobile to TV)	Yes
	Wi-Di	Yes
	Wi-Fi Direct	Yes
	Pro:Idiom	Yes
	SI Compatible	YES (MPI protocol/TVLink Tuner Protocol)
	Wi-Fi	Yes (Built-in type)
	Hotel Mode / PDM / Installer Menu	Yes (Installer Menu)
	IR Out	Yes (MPI Jack/RS232)
	IR In	Yes (Display Control 1 & 2, External IR Receiver)
	BT (Blue Tooth)	Yes (Built-in)
	Audio Line Out	Yes (3.5mm, Stereo, Single Ended (GND, L+,R+))
USB	USB 2.0	
Picture	JPEG	
Audio Codec	AC3 (Dolby Digital), EAC3, AAC, MPEG, MP3, PCM	
SAP (Soft Access Point)	Yes (Built-in)	
USB Cloning	Yes	
Logical Channel Map	Yes	
Multi IR Code	Yes	
Auto Off / Auto Sleep	Yes	
Video Mute	Yes	
Smart Energy Saving (Auto Power Off)	Yes	

INTERFACE (FRONT)	Model	STB-3000
INTERFACE (FRONT)	Display Control 2 (RJ-12)	Yes
	MPI	Yes
	HDMI (1,2)	Yes
	USB (1,2)	Yes
INTERFACE (REAR)	Power	Yes
	Tuner	Yes
	Display Control 1 (4 Pin 3.5mm Jack)	Yes
	External IR (3Pin 3.5mm Jack)	Yes
	Service (3 Pin 3.5mm Jack)	Yes
	AV In (4 Pin 3.5mm Jack)	Yes
	Digital Audio Out (Optical)	Yes
	LAN Port	Yes
	HDMI Out	Yes
ACCESSORIES	Adapter	Yes
	Cable	HDMI, MPI, RS232, AV gender
	Manual / ESG	Simple Book
REMOTE JACK PANEL COMPATIBILITY	  (HDMI-CEC)	
SYSTEM INTEGRATOR COMPATIBILITY	                 	
LG COMMERCIAL TV COMPATIBILITY	<ul style="list-style-type: none"> All LG hotel TVs with the MPI interface support are proven interoperable with the STB-3000, apart from the LP1 and LX3 models. All Commercial Lite models with RS.232 interface. Contact LG APD if you have compatibility issues with any LG commercial TV models. 	
NON-LG AND OTHERS COMPATIBILITY	<ul style="list-style-type: none"> Commercial hotel TVs supporting the MTI/MPI interface should be compatible with the STB-3000, but it is the System Integrators responsibility to perform verification testing using a sample TV prior to deployment or customer commitment. Issues found should be reported to LG APD. 	

All screen images are simulated. Dimensions and weights are approximate. Design, specifications, and features subject to change without notice.

© Copyright 2015 LG Electronics USA, Inc. All Rights Reserved. "LG Life's Good" is a registered trademark of LG Corp.

ENERGY STAR is a registered trademark of the U.S. Environmental Protection Agency. In Plane Switching is a trademark of LG Display Co., LTD. VESA is a trademark of Video Electronics Standards Association. HDMI, the HDMI logo and High-Definition Multimedia Interface are trademarks or registered trademarks of HDMI Licensing LLC.

All other product and brand names are trademarks or registered trademarks of their respective companies.



Printed in the USA. June 2015 LG_SPEC_ProCentric_STB3000_051521_PR



World Cinema, Inc.
9801 Westheimer
Suite 409
Houston, TX 77042

Phone: 713.266.2686
Toll Free: 1.800.944.9441
Fax: 713.780.7241
info@worldcinemainc.com

